



## CAB DOWN CRANE CD225

DATASHEET - IMPERIAL







# CD225

### Features:

- ▶ Rated capacity:  
25 ton @ 10 ft working radius
- ▶ Maximum boom length:  
72 ft
- ▶ Maximum tip height:  
121 ft

**WORKS FOR YOU.™**

	Page:
<b>Key</b>	
.....	3
<b>Dimensions</b>	
Crane dimensions .....	4
Crane weights .....	5
<b>Load Charts</b>	
Range Diagram – Main Boom – Outriggers fully extended (100%) .....	6
Load Chart – Main Boom – Outriggers fully extended (100%) .....	7
Range Diagram – Main Boom – 26 ft offsettable jib .....	8
Load Chart – Main Boom – 26 ft offsettable jib .....	9
Range Diagram – Main Boom – 43 ft offsettable jib .....	10
Load Chart – Main Boom – 43 ft offsettable jib .....	11
Range Diagram – Main Boom – On tires .....	12
Load Chart – Main Boom – On tires .....	13
<b>Technical Description</b>	
Boom .....	14
Hoist, rope and hook .....	14, 15
Superstructure .....	15
Cab, controls, operator aids and load limiter / load indicator .....	15, 16
Carrier, engine, drive-line and hydraulic system .....	16
Vehicle performance .....	17
Tires .....	17

	Counterweight		General performance
	Main boom		Telescoping mode
	Boom length		Boom luffing angle
	Tip height		Working radius
	Boom with extension		Max. boom length with extension
	Main boom with aux head		Distance from the hook to the head sheave pin
	Slewing / Allowable slewing range		Slewing locked / Slewing locked at specified position
	Slewing brake		Slewing gears
	Outriggers / Lifting on outriggers (100/50/0% extended)		Lifting on wheels / Pick & Carry
	Main hoist		Auxiliary hoist
	Hoist speed		Rope length
	Rope – Standard / Optional		Max. line pull
	Rope diameter		Tire
	Hook block		Controls
	Cab		Engine
	Operator aids / Load limiter / Load indicator		Steering
	Mechanical transmission		Speed
	Hydraulics		Heating / Air conditioning
	Working temperature		Gradeability
	Lights		Gross vehicle weight
	Crane / Crane in standard configuration		Weight on front axle
	Crane without counterweight		Weight on rear axle

# CRANE DIMENSIONS

**CD225**

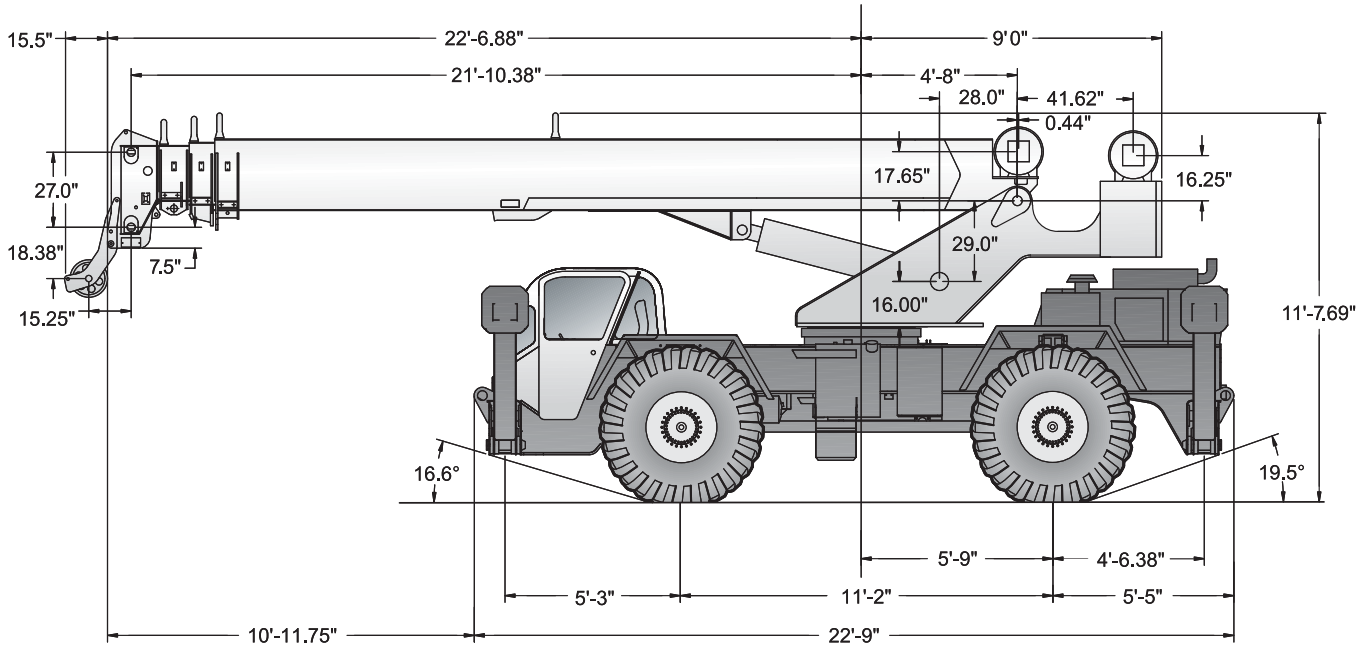

**Note:**

All heights are based on 20.5 x 25 tires. Use of 14.00 x 24 tires will reduce height by 2.5".

**Note:**



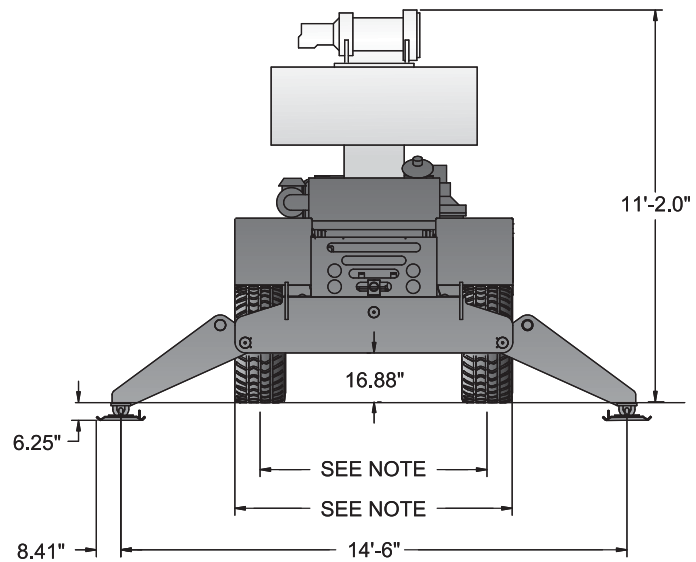



	14.00 x 24	20.5 x 25
Track width	6'-9.9"	6'-10.5"
Overall width	8'-0"	8'-8"

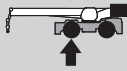
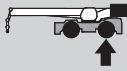
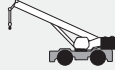

# CRANE WEIGHTS

**CD225**

## Approximate Weights

					
	STD (without hoo block and auxiliary hoist)		42,534 lb	20,480 lb	22,054 lb
Add / Subtract for main optional equipment					
	26 ft to 43 ft swing on jib stowed	61 ft boom 72 ft boom	+ 1490 lb + 1490 lb	+ 1944 lb + 2489 lb	- 454 lb - 999 lb
	Auxiliary boom head	61 ft boom 72 ft boom	+ 100 lb + 100 lb	+ 257 lb + 290 lb	- 158 lb + 191 lb
	Auxiliary hoist*		+ 115 lb	- 25 lb	+ 140 lb
	25T, 2 sheave hook block		+ 682 lb	+ 1155 lb	- 473 lb
	7T, hook and ball (in tool box)		+ 240 lb	+ 81 lb	+ 159 lb

NOTE: Values are subject to 2% variation

\* Weight includes rope

# RANGE DIAGRAM - MAIN BOOM

**CD225**

**Outriggers Fully Extended (100%)**

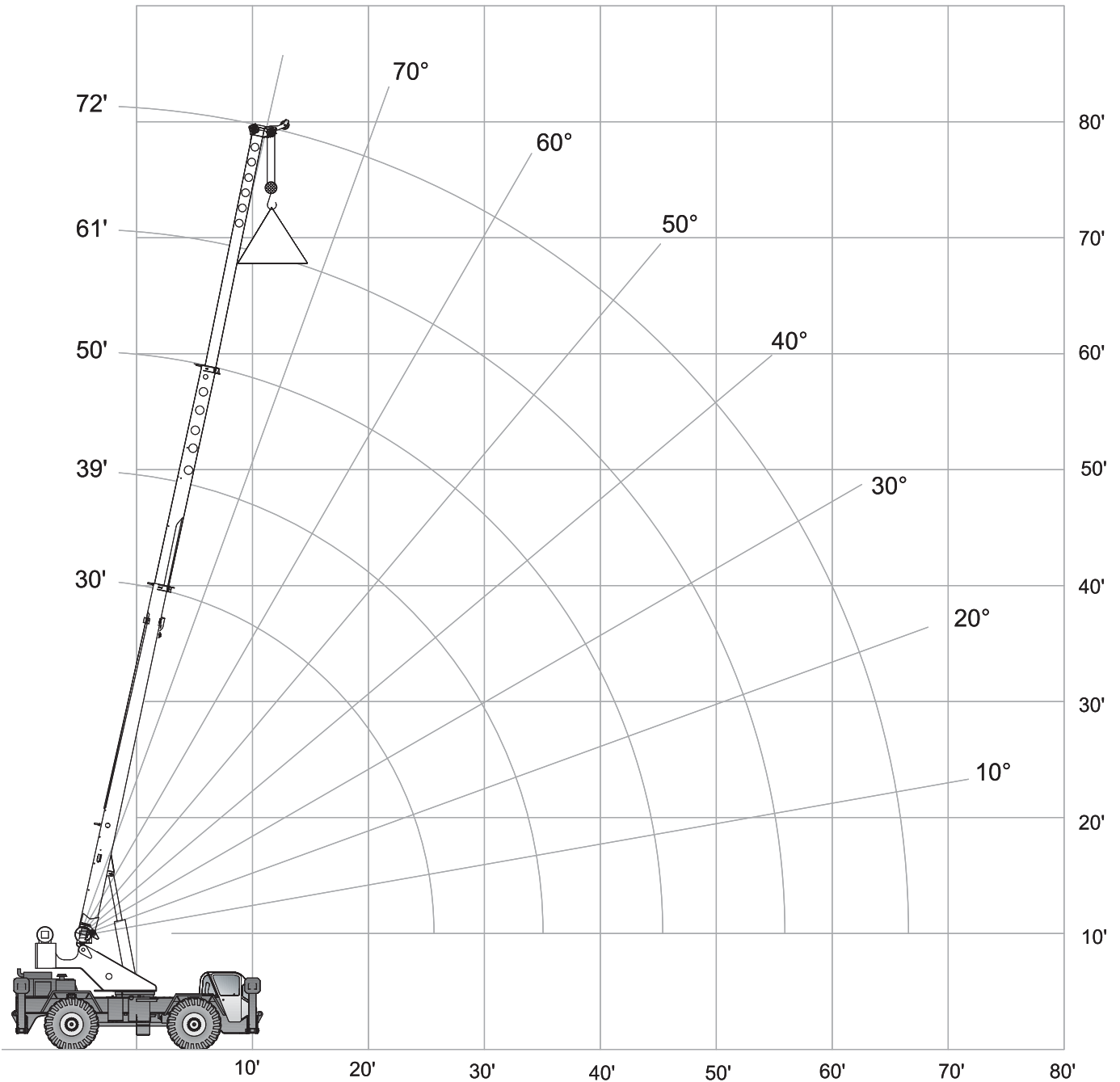
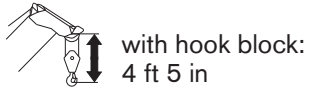
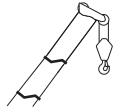

# LOAD CHART – MAIN BOOM

**CD225**



## Outriggers Fully Extended (100%)

 7,200 lbs

 14 ft 6 in (100%)

 360°

Standard ASME  
B30.5

	Boom Length					
	30 ft	39 ft	50 ft	61 ft	72 ft	
ft	lbs	lbs	lbs	lbs	lbs	ft
10	50,000	43,300				10
12	41,600	39,000	36,800			12
15	34,400	34,000	31,900	30,500		15
20	21,200	21,800	22,000	22,200	22,300	20
25	13,700	14,500	14,800	14,900	15,000	25
30		10,300	10,700	10,800	10,900	30
35			8,000	8,200	8,300	35
40			6,100	6,400	6,500	40
45			4,700	5,000	5,200	45
50				3,900	4,100	50
55				3,000	3,300	55
60					2,600	60
65					2,000	65

## Notes to lifting capacity

Lifting capacities do not exceed 85% of tipping load. Weight of hook blocks and slings is part of the load, and is to be deducted from the capacity ratings. Consult operation manual for further details.

Note: Data published herein is intended as a guide only and shall not be construed to warrant applicability for lifting purposes. Crane operation is subject to the computer charts and operation manual both supplied with the crane.

# RANGE DIAGRAM - MAIN BOOM

CD225

With Jib, 26 ft offset

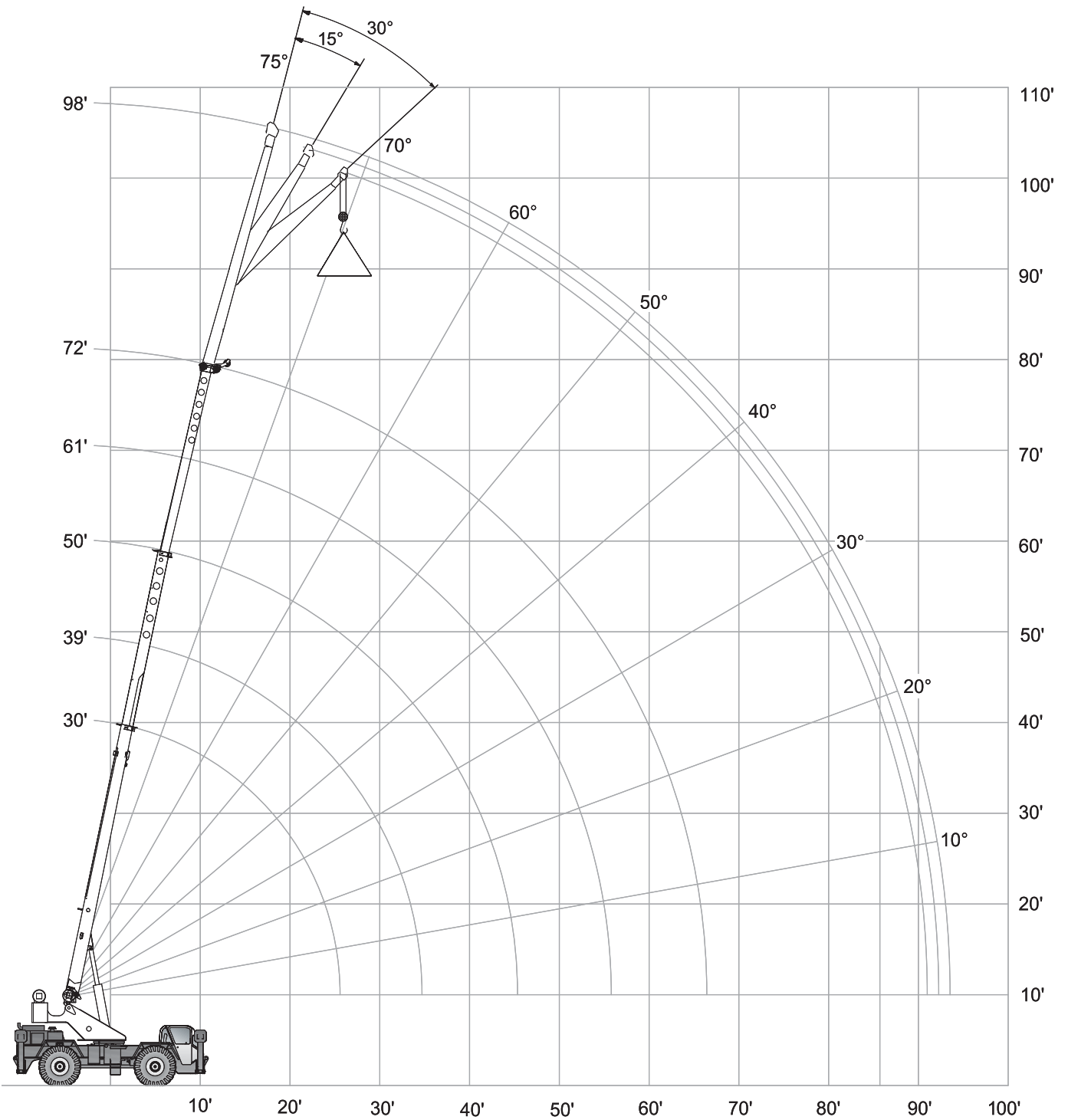
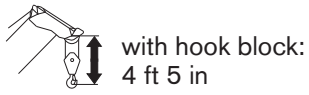
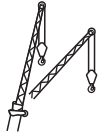



# LOAD CHART – MAIN BOOM

**CD225**



## With Jib, 26 ft offset

 7,200 lbs

 14 ft 6 in (100%)

 360°

Standard ASME  
B30.5

26 ft Offsettable Jib					
0°		15°		30°	
 ft	lbs	 ft	lbs	 ft	lbs
26 ft 7 in	13,000	31 ft 11 in	7,700	37 ft 6 in	5,000
29 ft 2 in	11,800	34 ft 11 in	7,200	35 ft 5 in	5,300
31 ft 11 in	9,700	37 ft 10 in	6,800	42 ft 4 in	5,100
36 ft 4 in	7,800	42 ft 6 in	6,400	46 ft 8 in	4,900
40 ft 8 in	6,200	47 ft 1 in	5,400	51 ft	4,700
45 ft	5,200	51 ft 5 in	4,600	55 ft 1 in	3,900
49 ft 9 in	4,400	55 ft 6 in	3,700	58 ft 11 in	3,300
54 ft 10 in	3,500	60 ft 8 in	3,000	63 ft 3 in	2,700
60 ft 11 in	2,800	65 ft 5 in	2,500	67 ft 9 in	2,300
65 ft 7 in	2,200	70 ft 1 in	2,000	72 ft 3 in	1,900
70 ft 4 in	1,800	74 ft 5 in	1,600	76 ft 2 in	1,500
75 ft 8 in	1,400	79 ft 1 in	1,200	80 ft 5 in	1,100
80 ft 11 in	900	83 ft 9 in	800	84 ft 6 in	800
85 ft 11 in	600	88 ft 1 in	500		

## Notes to lifting capacity

Lifting capacities do not exceed 85% of tipping load. Weight of hook blocks and slings is part of the load, and is to be deducted from the capacity ratings. Consult operation manual for further details.

Note: Data published herein is intended as a guide only and shall not be construed to warrant applicability for lifting purposes. Crane operation is subject to the computer charts and operation manual both supplied with the crane.

# RANGE DIAGRAM - MAIN BOOM

CD225

With Jib, 43 ft offset

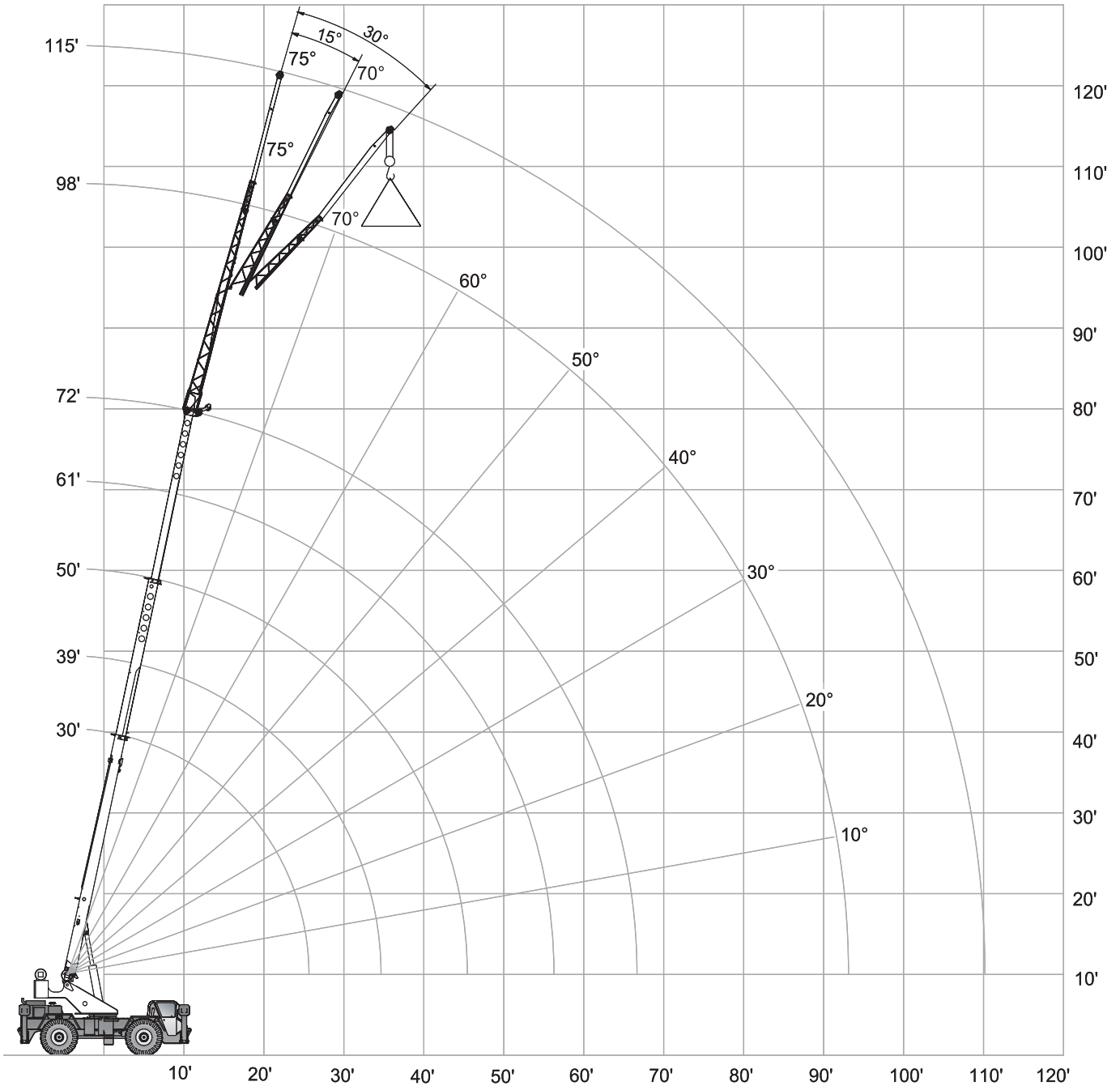
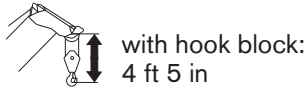
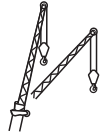

# LOAD CHART – MAIN BOOM

**CD225**



## With Jib, 43 ft offset

 7,200 lbs

 14 ft 6 in (100%)

 360°

Standard ASME  
B30.5

43 ft Offsettable Jib					
0°		15°		30°	
 ft	lbs	 ft	lbs	 ft	lbs
29 ft 10 in	5,000	33 ft 7 in	3,300	47 ft 2 in	2,400
33 ft 9 in	4,800	39 ft 7 in	3,100	51 ft 5 in	2,300
39 ft 1 in	4,600	45 ft 5 in	2,900	55 ft 3 in	2,300
46 ft 2 in	4,300	52 ft 9 in	2,700	60 ft 9 in	2,200
52 ft 6 in	3,900	58 ft 11 in	2,500	65 ft 6 in	2,200
58 ft 1 in	3,500	64 ft 6 in	2,400	69 ft 11 in	2,100
63 ft 3 in	3,200	69 ft 5 in	2,300	74 ft	2,100
69 ft 6 in	2,600	75 ft 3 in	2,200	79 ft 1 in	2,100
75 ft 1 in	2,100	80 ft 6 in	1,800	83 ft 9 in	1,700
80 ft 3 in	1,600	85 ft 3 in	1,400	87 ft 11 in	1,300
85 ft	1,300	89 ft 7 in	1,100	91 ft 10 in	1,000
90 ft 6 in	900	94 ft 6 in	800	96 ft 2 in	700
96 ft 3 in	600	99 ft 7 in	500	101 ft	500

## Notes to lifting capacity

Lifting capacities do not exceed 85% of tipping load. Weight of hook blocks and slings is part of the load, and is to be deducted from the capacity ratings. Consult operation manual for further details.

Note: Data published herein is intended as a guide only and shall not be construed to warrant applicability for lifting purposes. Crane operation is subject to the computer charts and operation manual both supplied with the crane.

# RANGE DIAGRAM - MAIN BOOM

CD225

## On Tires

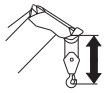
 with hook block:  
4 ft 5 in

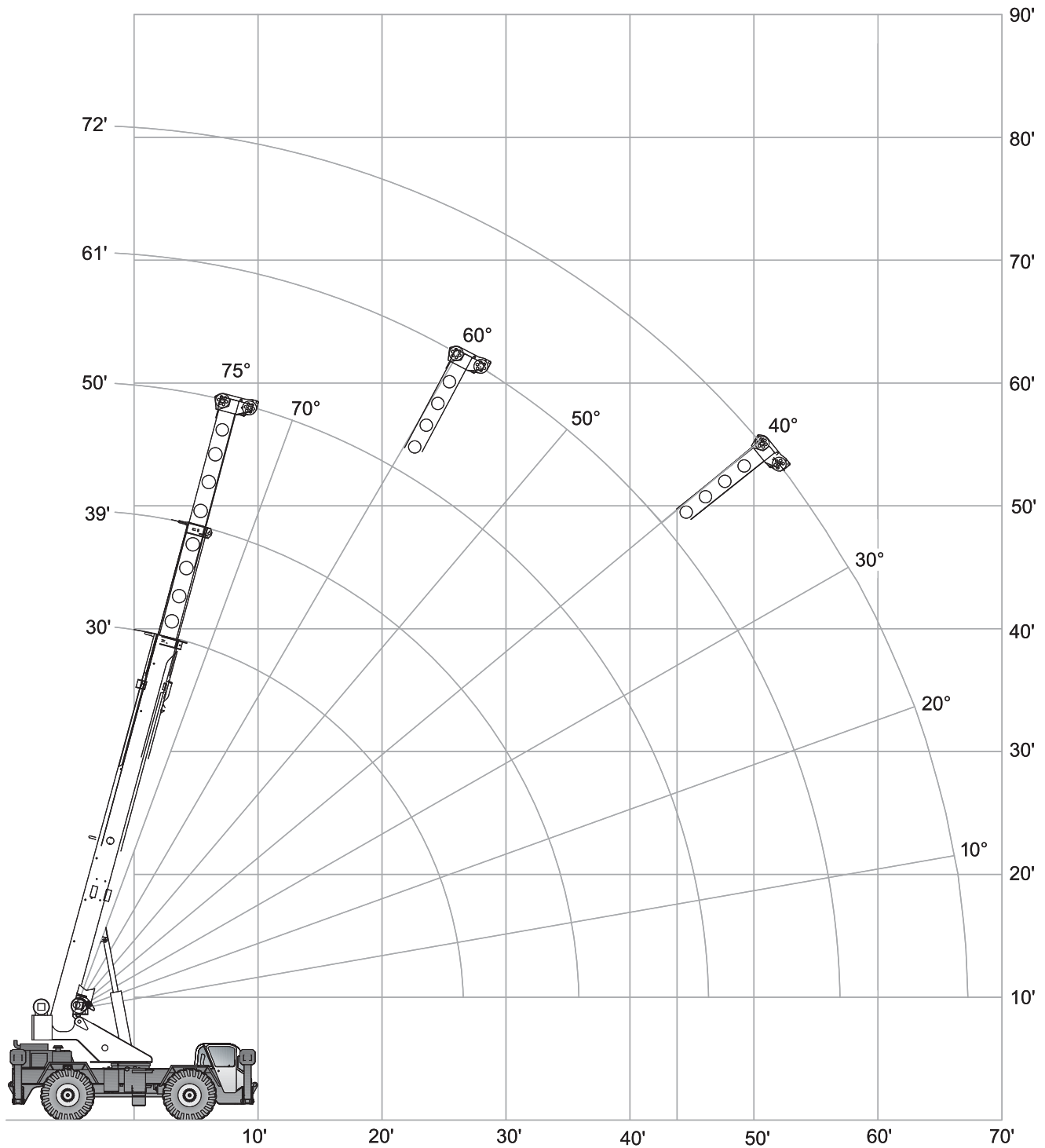
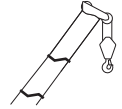

# LOAD CHART – MAIN BOOM

**CD225**

## On Tires

 7,200 lbs

 360°

 On tires  
20.5 x 25-24 PR

Standard ASME  
B30.5





Boom		Travel Speed Boom straight over front		
Radius	Length	0 mph	Creep	2.5 mph
ft	ft	lbs	lbs	lbs
10	30	18,600	35,800	25,700
12	30	14,800	30,400	22,100
15	39	11,100	22,200	18,000
20	39	6,400	12,600	12,600
25	50	4,100	8,900	8,900
30	50	2,800	6,600	6,600
35	50	2,000	4,900	4,900
40	61	1,200	3,800	3,800
45	61	700	2,800	2,800
50	61		2,200	2,200
55	72		1,700	1,700
60	72		1,200	1,200
65	72		900	900

## Notes to lifting capacity







Lifting capacities do not exceed 85% of tipping load. Weight of hook blocks and slings is part of the load, and is to be deducted from the capacity ratings. Consult operation manual for further details.







Note: Data published herein is intended as a guide only and shall not be construed to warrant applicability for lifting purposes. Crane operation is subject to the computer charts and operation manual both supplied with the crane.

## Boom



Standard configuration:		
	3 sections hydraulic actuated boom	
	Full power mechanically synchronized	
	Min. / Max.	30 ft / 72 ft
	Boom elevation angle range (min. / max.)	-4° / 76°
Optional configuration:		
	One section jib	26 ft
	Offset	0, 15 and 30 degrees
	Maximum tip height	103 ft
	Two section jib	26 ft to 43 ft
	Offset	0, 15 and 30 degrees
	Maximum tip height	121 ft

## Hoist, Rope and Hook



Standard configuration:		
	Grooved drum Storage capacity	570 ft
	Two speed ratios	
	Without load in 5 <sup>th</sup> layer (low range / high range) Without load in 1 <sup>st</sup> layer (low range / high range)	227 ft/min / 364 ft/min 157 ft/min / 252 ft/min
	6 x 19 IWRC XIPS, right regular lay, preformed	
		5/8 in
		455 ft
	Max. line pull; 1 <sup>st</sup> layer low-range	12,510 lbs
	Max. line pull permissible	9,000 lbs

Optional configuration:		
	Hook and ball 2 sheaves 3 sheaves 4 sheaves	239 lbs 680 lbs 660 lbs 660 lbs
	Grooved drum Storage capacity	570 ft
	Without load in 5 <sup>th</sup> layer (low range / high range) Without load in 1 <sup>st</sup> layer (low range / high range)	227 ft/min / 364 ft/min 157 ft/min / 252 ft/min
	Rotation resistant compacted strand 18 x 19 or 19 x 19	
		5/8 in
		455 ft
	Minimum breaking strength Max. line pull permissible	35,800 lbs 9,000 lbs

## Superstructure

Standard configuration:		
	Non stop Maximum rotation speed without load	360° 3 rpm
	Hydraulic motor Planetary reducer	
	360° house lock Manually actuated by foot pedal	

## Cab, Controls, Operator aids and Load limiter / Load indicator

Standard configuration:		
	Rubber floor mat Tinted safety glass Six way adjustable seat	
	Armrest mounted dual axis electro-proportional joysticks Steering wheel column with gear selector on the left and directional light selector on the right Dashboard mounted switches for outrigger operation	
	Graphic interface for load indicator	

## Optional configuration:



Hydraulic powered air conditioner  
 Hydraulic powered heater  
 Work lights  
 Rotating beacon

## Carrier, Engine, Drive-line and Hydraulic system

### Standard configuration:



Hydraulic, independent extension:  
 Diameter of outrigger pads  
 Area of outrigger pads

24 in  
 452 in<sup>2</sup>



Cummins QSB4.5 4 cylinders  
 Rated power  
 Maximum gross torque  
 Intake: turbocharger with intercooler  
 Fuel type  
 Fuel tank capacity

130 hp @ 2,300 rpm  
 459 ft·lb @ 1,500 rpm  
 Diesel  
 50 gallons



6 x 6 powershift transmission with integral torque converter  
 Full time 4WD (Four-Wheel Drive)  
 Rigid mounted front axle  
 Oscillating rear axle  
 Differential lock on front axle and rear axle  
 Rear axle oscillation lock – manual or automatic actuation  
 Air-over-hydraulic disc brakes  
 Parking brake on front axle  
 Hydraulic oil cooler on carrier



Hydraulic power steering  
 Front wheel steering  
 Four wheel steering concentric  
 Four wheel steering crab  
 Optional rear wheel steering package





Hydraulic Pumps:  
**Tandem pumps:**  
 Boom lift / Telescope  
 Power steering / Outriggers and Swing  
**Single pump:**  
 Main and auxiliary hoist pump

30 gal/min @ 3,500 psi  
 21 gal/min @ 2,500 psi  
 41 gal/min @ 3,500 psi



Hydraulic oil reservoir capacity 94 gallons  
 Hydraulic oil suction filter 250 microns  
 Hydraulic oil return filter 5 microns



## Vehicle performance

		Standard configuration:	
	Max. in 1 <sup>st</sup> gear (low range)		112 %
	Max. in 3 <sup>rd</sup> gear (high range)		3.8 %
	Max. (6 <sup>th</sup> gear)		24.5 mph

## Tires

		Standard configuration:	
	Wide tread earth mover pattern (E3)		20.5 x 25-20 PR
	Industrial pattern	Optional configuration:	14.00 x 24-20 PR

[www.terexcranes.com](http://www.terexcranes.com)

Effective Date: October 2010.

Product specifications and prices are subject to change without notice or obligation. The photographs and/or drawings in this document are for illustrative purposes only. Refer to the appropriate Operator's Manual for instructions on the proper use of this equipment. Failure to follow the appropriate Operator's Manual when using our equipment or to otherwise act irresponsibly may result in serious injury or death. The only warranty applicable to our equipment is the standard written warranty applicable to the particular product and sale and Terex makes no other warranty, express or implied. Products and services listed may be trademarks, service marks or trade-names of Terex Corporation and/or its subsidiaries in the USA and other countries. All rights are reserved. Terex® is a registered trademark of Terex Corporation in the USA and many other countries.

Copyright 2010 Terex Corporation

Terex Cranes, Global Marketing, Dinglerstraße 24, 66482 Zweibrücken, Germany  
Tel. +49 (0) 6332 830, Email: [info.cranes@terex.com](mailto:info.cranes@terex.com), [www.terexcranes.com](http://www.terexcranes.com)

Brochure Reference: TC-DS-I-E-CD225-10/10



**WORKS FOR YOU.™**